



ПОСТАВЩИК СОЕДИНИТЕЛЬНОЙ И РЕГУЛИРУЮЩЕЙ АРМАТУРЫ





Компания «Стальные технологии»

специализируется на поставках элементов оборудования производства чешской фирмы «Niob Fluid» промышленным предприятиям, специфика работы которых связана с транспортировкой жидкостей. Программа деятельности нашей компании ориентирована на сотрудничество с предприятиями пищевой, фармацевтической, химической и нефтегазовой промышленности.

Мы поставляем соединительные, регулирующие, запорные арматуры, трубы, трубные фасонные части и другие элементы технологического оборудования из нержавеющей стали и стремимся к тому, чтобы Ваше предприятие, оснащенное высококачественным оборудованием, всегда поставляло потребителю продукцию на уровне мировых стандартов.

Угольник 90° С - С

30010

Размеры

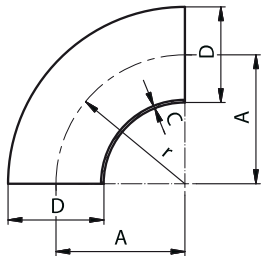

| DN | D | A | C | r | | | | | | kg |
|-----|-----|-------|-----|-------|--|--|--|--|--|------|
| 10 | 12 | 26 | 1,5 | 26 | | | | | | 0,02 |
| 10 | 13 | 26 | 1,5 | 26 | | | | | | 0,02 |
| 15 | 18 | 35 | 1,5 | 35 | | | | | | 0,04 |
| 15 | 19 | 35 | 1,5 | 35 | | | | | | 0,04 |
| 20 | 22 | 40 | 1,5 | 40 | | | | | | 0,04 |
| 20 | 23 | 40 | 1,5 | 40 | | | | | | 0,08 |
| 25 | 28 | 50 | 1,5 | 50 | | | | | | 0,08 |
| 25 | 29 | 50 | 1,5 | 50 | | | | | | 0,08 |
| 32 | 34 | 55 | 1,5 | 55 | | | | | | 0,10 |
| 32 | 35 | 55 | 1,5 | 55 | | | | | | 0,10 |
| 40 | 40 | 60 | 1,5 | 60 | | | | | | 0,20 |
| 40 | 41 | 60 | 1,5 | 60 | | | | | | 0,20 |
| 50 | 52 | 70 | 1,5 | 70 | | | | | | 0,20 |
| 50 | 53 | 70 | 1,5 | 70 | | | | | | 0,20 |
| 65 | 70 | 80 | 2,0 | 80 | | | | | | 0,40 |
| 80 | 85 | 90 | 2,0 | 90 | | | | | | 0,56 |
| 100 | 104 | 100 | 2,0 | 100 | | | | | | 0,76 |
| 125 | 129 | 187,5 | 2,0 | 187,5 | | | | | | 1,64 |
| 150 | 154 | 225 | 2,0 | 225 | | | | | | 2,60 |

Угольник 90° W - W

30020

Размеры

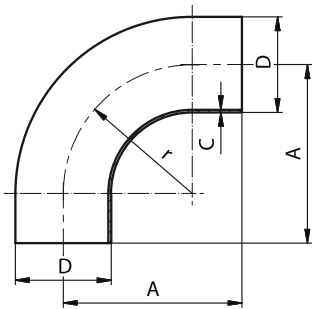

| DN | D | A | C | r | | | | | | kg |
|-----|-----|-----|-----|-----|--|--|--|--|--|------|
| 10 | 12 | 38 | 1,5 | 26 | | | | | | 0,02 |
| 10 | 13 | 38 | 1,5 | 26 | | | | | | 0,02 |
| 15 | 18 | 47 | 1,5 | 35 | | | | | | 0,04 |
| 15 | 19 | 47 | 1,5 | 35 | | | | | | 0,04 |
| 20 | 22 | 52 | 1,5 | 40 | | | | | | 0,06 |
| 20 | 23 | 52 | 1,5 | 40 | | | | | | 0,06 |
| 25 | 28 | 70 | 1,5 | 50 | | | | | | 0,12 |
| 25 | 29 | 70 | 1,5 | 50 | | | | | | 0,12 |
| 32 | 34 | 78 | 1,5 | 52 | | | | | | 0,16 |
| 32 | 35 | 78 | 1,5 | 52 | | | | | | 0,16 |
| 40 | 40 | 90 | 1,5 | 60 | | | | | | 0,20 |
| 40 | 41 | 90 | 1,5 | 60 | | | | | | 0,20 |
| 50 | 52 | 100 | 1,5 | 72 | | | | | | 0,28 |
| 50 | 53 | 100 | 1,5 | 72 | | | | | | 0,28 |
| 65 | 70 | 110 | 2,0 | 85 | | | | | | 0,56 |
| 80 | 85 | 130 | 2,0 | 93 | | | | | | 0,78 |
| 100 | 104 | 150 | 2,0 | 110 | | | | | | 1,10 |

Угольник 90° P - C

30040

Размеры

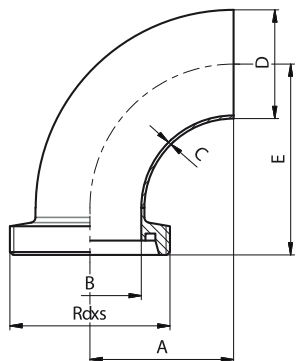

| DN | A | B | C | D | E | F | R | L | Rd x s | kg |
|-----|-------|-----|-----|-----|-----|---|---|---|---------|------|
| 10 | 26 | 10 | 1,5 | 13 | 43 | | | | 28x1/8 | 0,06 |
| 15 | 35 | 16 | 1,5 | 19 | 52 | | | | 34x1/8 | 0,08 |
| 20 | 40 | 20 | 1,5 | 23 | 59 | | | | 44x1/6 | 0,12 |
| 25 | 50 | 26 | 1,5 | 29 | 72 | | | | 52x1/6 | 0,18 |
| 32 | 55 | 32 | 1,5 | 35 | 77 | | | | 58x1/6 | 0,22 |
| 40 | 60 | 38 | 1,5 | 41 | 82 | | | | 65x1/6 | 0,36 |
| 50 | 70 | 50 | 1,5 | 53 | 93 | | | | 78x1/6 | 0,42 |
| 65 | 80 | 66 | 2,0 | 70 | 105 | | | | 95x1/6 | 0,74 |
| 80 | 90 | 81 | 2,0 | 85 | 116 | | | | 110x1/4 | 1,06 |
| 100 | 100 | 100 | 2,0 | 104 | 130 | | | | 130x1/4 | 1,50 |
| 125 | 187,5 | 125 | 2,0 | 129 | 223 | | | | 160x1/4 | 1,75 |
| 150 | 225 | 150 | 2,0 | 154 | 265 | | | | 190x1/4 | 2,01 |

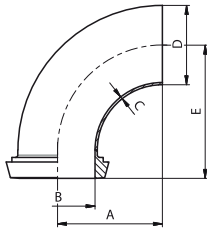
| Угольник 90° К - С | 30050 | Размеры | | | | | | | | | | | |
|---|-------|---------|-------|-----|-----|-----|-------|---|---|---|--------|----|------|
| | | DN | A | B | C | D | E | F | R | L | Rd x s | kg | |
|  | | 10 | 26 | 10 | 1,5 | 13 | 40 | | | | | | 0,04 |
| | | 15 | 35 | 16 | 1,5 | 19 | 49 | | | | | | 0,06 |
| | | 20 | 40 | 20 | 1,5 | 23 | 56 | | | | | | 0,10 |
| | | 25 | 50 | 26 | 1,5 | 29 | 68 | | | | | | 0,16 |
| | | 32 | 55 | 32 | 1,5 | 35 | 73 | | | | | | 0,20 |
| | | 40 | 60 | 38 | 1,5 | 41 | 78 | | | | | | 0,34 |
| | | 50 | 70 | 50 | 1,5 | 53 | 89 | | | | | | 0,40 |
| | | 65 | 80 | 66 | 2,0 | 70 | 101 | | | | | | 0,72 |
| | | 80 | 90 | 81 | 2,0 | 85 | 111 | | | | | | 1,04 |
| | | 100 | 100 | 100 | 2,0 | 104 | 125 | | | | | | 1,48 |
| | | 125 | 187,5 | 125 | 2,0 | 129 | 214,5 | | | | | | 1,73 |
| | | 150 | 225 | 150 | 2,0 | 154 | 254 | | | | | | 1,89 |

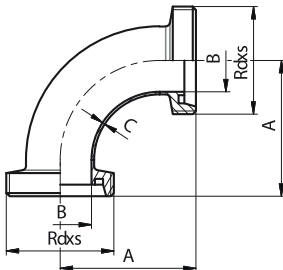
| Угольник 90° P - P | 30060 | Размеры | | | | | | | | | | | |
|--|-------|---------|-----|-----|-----|---|---|---|---|---|---------|----|------|
| | | DN | A | B | C | D | E | F | R | L | Rd x s | kg | |
|  | | 10 | 43 | 10 | 1,5 | | | | | | 28x1/8 | | 0,10 |
| | | 15 | 52 | 16 | 1,5 | | | | | | 34x1/8 | | 0,15 |
| | | 20 | 59 | 20 | 1,5 | | | | | | 44x1/6 | | 0,26 |
| | | 25 | 72 | 26 | 1,5 | | | | | | 52x1/6 | | 0,35 |
| | | 32 | 77 | 32 | 1,5 | | | | | | 58x1/6 | | 0,41 |
| | | 40 | 82 | 38 | 1,5 | | | | | | 65x1/6 | | 0,51 |
| | | 50 | 93 | 50 | 1,5 | | | | | | 78x1/6 | | 0,72 |
| | | 65 | 105 | 66 | 2,0 | | | | | | 95x1/6 | | 1,06 |
| | | 80 | 116 | 81 | 2,0 | | | | | | 110x1/4 | | 1,73 |
| | | 100 | 130 | 100 | 2,0 | | | | | | 130x1/4 | | 2,18 |
| | | 125 | 223 | 125 | 2,0 | | | | | | 160x1/4 | | 4,21 |
| | | 150 | 265 | 150 | 2,0 | | | | | | 190x1/4 | | 6,66 |

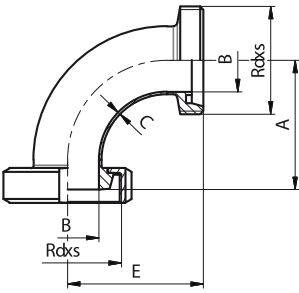
| Угольник 90° К/М - P | 30070 | Размеры | | | | | | | | | | | |
|---|-------|---------|-------|-----|-----|---|-----|---|---|---|---------|----|------|
| | | DN | A | B | C | D | E | F | R | L | Rd x s | kg | |
|  | | 10 | 40 | 10 | 1,5 | | 43 | | | | 28x1/8 | | 0,16 |
| | | 15 | 49 | 16 | 1,5 | | 52 | | | | 34x1/8 | | 0,21 |
| | | 20 | 56 | 20 | 1,5 | | 59 | | | | 44x1/6 | | 0,34 |
| | | 25 | 68 | 26 | 1,5 | | 72 | | | | 52x1/6 | | 0,47 |
| | | 32 | 73 | 32 | 1,5 | | 77 | | | | 58x1/6 | | 0,57 |
| | | 40 | 78 | 38 | 1,5 | | 82 | | | | 65x1/6 | | 0,70 |
| | | 50 | 89 | 50 | 1,5 | | 93 | | | | 78x1/6 | | 0,97 |
| | | 65 | 101 | 66 | 2,0 | | 105 | | | | 95x1/6 | | 1,52 |
| | | 80 | 111 | 81 | 2,0 | | 115 | | | | 110x1/4 | | 2,23 |
| | | 100 | 125 | 100 | 2,0 | | 130 | | | | 130x1/4 | | 3,01 |
| | | 125 | 214,5 | 125 | 2,0 | | 223 | | | | 160x1/4 | | 4,21 |
| | | 150 | 254 | 150 | 2,0 | | 265 | | | | 190x1/4 | | 8,01 |

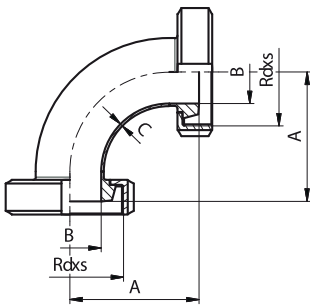
| Угольник 90° К/М - К/М | 30080 | Размеры | | | | | | | | | | | |
|---|-------|---------|-------|-----|-----|---|---|---|---|---|---------|----|------|
| | | DN | A | B | C | D | E | F | R | L | Rd x s | kg | |
|  | | 10 | 40 | 10 | 1,5 | | | | | | 28x1/8 | | 0,21 |
| | | 15 | 49 | 16 | 1,5 | | | | | | 34x1/8 | | 0,27 |
| | | 20 | 56 | 20 | 1,5 | | | | | | 44x1/6 | | 0,42 |
| | | 25 | 68 | 26 | 1,5 | | | | | | 52x1/6 | | 0,63 |
| | | 32 | 73 | 32 | 1,5 | | | | | | 58x1/6 | | 0,73 |
| | | 40 | 78 | 38 | 1,5 | | | | | | 65x1/6 | | 0,87 |
| | | 50 | 89 | 50 | 1,5 | | | | | | 78x1/6 | | 1,23 |
| | | 65 | 101 | 66 | 2,0 | | | | | | 95x1/6 | | 1,99 |
| | | 80 | 111 | 81 | 2,0 | | | | | | 110x1/4 | | 2,73 |
| | | 100 | 125 | 100 | 2,0 | | | | | | 130x1/4 | | 3,84 |
| | | 125 | 214,5 | 125 | 2,0 | | | | | | 160x1/4 | | 6,37 |
| | | 150 | 254 | 150 | 2,0 | | | | | | 190x1/4 | | 9,36 |

Угольник 90° Ц-Ц

30090

Размеры

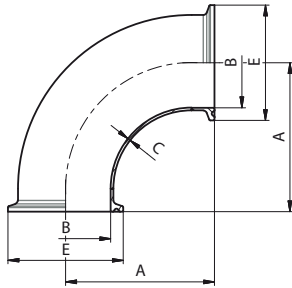

| DN | A | B | C | D | E | F | r | L | Rd x s | kg |
|-----|-------|-----|-----|---|------|---|---|---|--------|------|
| 10 | 38,7 | 10 | 1,5 | | 34 | | | | | 0,08 |
| 15 | 47,7 | 16 | 1,5 | | 34 | | | | | 0,09 |
| 20 | 52,7 | 20 | 1,5 | | 34 | | | | | 0,10 |
| 25 | 62,7 | 26 | 1,5 | | 50,5 | | | | | 0,20 |
| 32 | 67,7 | 32 | 1,5 | | 50,5 | | | | | 0,23 |
| 40 | 72,7 | 38 | 1,5 | | 50,5 | | | | | 0,28 |
| 50 | 82,7 | 50 | 1,5 | | 64 | | | | | 0,32 |
| 65 | 92,7 | 66 | 2,0 | | 91 | | | | | 0,62 |
| 80 | 102,7 | 81 | 2,0 | | 106 | | | | | 0,92 |
| 100 | 115,8 | 100 | 2,0 | | 119 | | | | | 1,13 |
| | | | | | | | | | | |
| | | | | | | | | | | |

Угольник 90° Ц-С

30091

Размеры

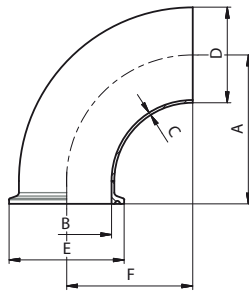

| DN | A | B | C | D | E | F | r | L | Rd x s | kg |
|-----|---|-----|-----|-----|------|---|---|---|--------|------|
| 10 | | 10 | 1,5 | 13 | 34 | | | | | 0,04 |
| 15 | | 16 | 1,5 | 19 | 34 | | | | | 0,05 |
| 20 | | 20 | 1,5 | 23 | 34 | | | | | 0,06 |
| 25 | | 26 | 1,5 | 29 | 50,5 | | | | | 0,08 |
| 32 | | 32 | 1,5 | 35 | 50,5 | | | | | 0,10 |
| 40 | | 38 | 1,5 | 41 | 50,5 | | | | | 0,11 |
| 50 | | 50 | 1,5 | 53 | 64 | | | | | 0,15 |
| 65 | | 66 | 2,0 | 70 | 91 | | | | | 0,34 |
| 80 | | 81 | 2,0 | 85 | 106 | | | | | 0,46 |
| 100 | | 100 | 2,0 | 104 | 119 | | | | | 0,56 |
| | | | | | | | | | | |
| | | | | | | | | | | |

| Угольник 45° С - С | 30100 | Размеры | | | | | | | | | | |
|--------------------|-------|---------|---|---|-----|-----|---|---|---|---|--------|------|
| | | DN | A | B | C | D | E | F | R | L | Rd x s | kg |
| | 10 | | | | 1,5 | 12 | | | | | | 0,01 |
| | 10 | | | | 1,5 | 13 | | | | | | 0,01 |
| | 15 | | | | 1,5 | 18 | | | | | | 0,02 |
| | 15 | | | | 1,5 | 19 | | | | | | 0,02 |
| | 20 | | | | 1,5 | 22 | | | | | | 0,02 |
| | 20 | | | | 1,5 | 23 | | | | | | 0,02 |
| | 25 | | | | 1,5 | 28 | | | | | | 0,04 |
| | 25 | | | | 1,5 | 29 | | | | | | 0,04 |
| | 32 | | | | 1,5 | 34 | | | | | | 0,05 |
| | 32 | | | | 1,5 | 35 | | | | | | 0,05 |
| | 40 | | | | 1,5 | 40 | | | | | | 0,07 |
| | 40 | | | | 1,5 | 41 | | | | | | 0,07 |
| | 50 | | | | 1,5 | 52 | | | | | | 0,10 |
| | 50 | | | | 1,5 | 53 | | | | | | 0,10 |
| | 65 | | | | 2,0 | 70 | | | | | | 0,21 |
| | 80 | | | | 2,0 | 85 | | | | | | 0,30 |
| | 100 | | | | 2,0 | 104 | | | | | | 0,40 |
| | 125 | | | | 2,0 | 129 | | | | | | 0,95 |
| | 150 | | | | 2,0 | 154 | | | | | | 1,40 |

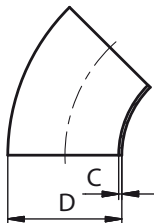

| Угольник 45° P - C | 30130 | Размеры | | | | | | | | | | |
|--------------------|-------|---------|---|-----|-----|-----|---|---|---|---|---------|------|
| | | DN | A | B | C | D | E | F | R | L | Rd x s | kg |
| | 10 | | | 10 | 1,5 | 13 | | | | | 28x1/8 | 0,05 |
| | 15 | | | 16 | 1,5 | 19 | | | | | 34x1/8 | 0,07 |
| | 20 | | | 20 | 1,5 | 23 | | | | | 44x1/6 | 0,13 |
| | 25 | | | 26 | 1,5 | 29 | | | | | 52x1/6 | 0,17 |
| | 32 | | | 32 | 1,5 | 35 | | | | | 58x1/6 | 0,21 |
| | 40 | | | 38 | 1,5 | 41 | | | | | 65x1/6 | 0,25 |
| | 50 | | | 50 | 1,5 | 53 | | | | | 78x1/6 | 0,35 |
| | 65 | | | 66 | 2,0 | 70 | | | | | 95x1/6 | 0,58 |
| | 80 | | | 81 | 2,0 | 85 | | | | | 110x1/4 | 0,86 |
| | 100 | | | 100 | 2,0 | 104 | | | | | 130x1/4 | 1,09 |
| | 125 | | | 125 | 2,0 | 129 | | | | | 160x1/4 | 2,10 |
| | 150 | | | 150 | 2,0 | 154 | | | | | 190x1/4 | 3,33 |

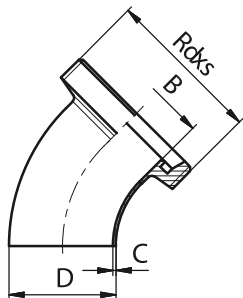

| Угольник 45° K - C | 30140 | Размеры | | | | | | | | | | |
|--------------------|-------|---------|---|-----|-----|-----|------|---|---|---|--------|------|
| | | DN | A | B | C | D | E | F | R | L | Rd x s | kg |
| | 10 | | | 10 | 1,5 | 13 | 22,5 | | | | | 0,03 |
| | 15 | | | 16 | 1,5 | 19 | 28,5 | | | | | 0,04 |
| | 20 | | | 20 | 1,5 | 23 | 36,5 | | | | | 0,08 |
| | 25 | | | 26 | 1,5 | 29 | 44 | | | | | 0,12 |
| | 32 | | | 32 | 1,5 | 35 | 50 | | | | | 0,15 |
| | 40 | | | 38 | 1,5 | 41 | 56 | | | | | 0,18 |
| | 50 | | | 50 | 1,5 | 43 | 68,5 | | | | | 0,26 |
| | 65 | | | 66 | 2,0 | 70 | 86 | | | | | 0,47 |
| | 80 | | | 81 | 2,0 | 85 | 100 | | | | | 0,58 |
| | 100 | | | 100 | 2,0 | 104 | 121 | | | | | 0,87 |
| | 125 | | | 125 | 2,0 | 129 | 150 | | | | | 1,66 |
| | 150 | | | 150 | 2,0 | 154 | 176 | | | | | 2,31 |

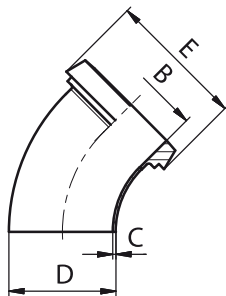

Угольник 45° P - P

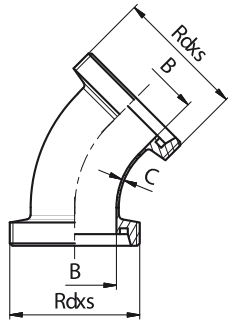
30150
Размеры

| DN | A | B | C | D | E | F | R | L | Rd x s | kg |
|-----|---|-----|-----|---|---|---|---|---|---------|------|
| 10 | | 10 | 1,5 | | | | | | 28x1/8 | 0,09 |
| 15 | | 16 | 1,5 | | | | | | 34x1/8 | 0,13 |
| 20 | | 20 | 1,5 | | | | | | 44x1/6 | 0,24 |
| 25 | | 26 | 1,5 | | | | | | 52x1/6 | 0,31 |
| 32 | | 32 | 1,5 | | | | | | 58x1/6 | 0,36 |
| 40 | | 38 | 1,5 | | | | | | 65x1/6 | 0,44 |
| 50 | | 50 | 1,5 | | | | | | 78x1/6 | 0,60 |
| 65 | | 66 | 2,0 | | | | | | 95x1/6 | 0,95 |
| 80 | | 81 | 2,0 | | | | | | 110x1/4 | 1,43 |
| 100 | | 100 | 2,0 | | | | | | 130x1/4 | 1,77 |
| 125 | | 125 | 2,0 | | | | | | 160x1/4 | 3,26 |
| 150 | | 150 | 2,0 | | | | | | 190x1/4 | 5,31 |

Угольник 45° K/M - P

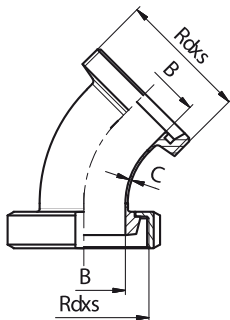
30160
Размеры

| DN | A | B | C | D | E | F | R | L | Rd x s | kg |
|-----|---|-----|-----|---|---|---|---|---|---------|------|
| 10 | | 10 | 1,5 | | | | | | 28x1/8 | 0,15 |
| 15 | | 16 | 1,5 | | | | | | 34x1/8 | 0,19 |
| 20 | | 20 | 1,5 | | | | | | 44x1/6 | 0,32 |
| 25 | | 26 | 1,5 | | | | | | 52x1/6 | 0,43 |
| 32 | | 32 | 1,5 | | | | | | 58x1/6 | 0,52 |
| 40 | | 38 | 1,5 | | | | | | 65x1/6 | 0,62 |
| 50 | | 50 | 1,5 | | | | | | 78x1/6 | 0,86 |
| 65 | | 66 | 2,0 | | | | | | 95x1/6 | 1,41 |
| 80 | | 81 | 2,0 | | | | | | 110x1/4 | 1,93 |
| 100 | | 100 | 2,0 | | | | | | 130x1/4 | 2,61 |
| 125 | | 125 | 2,0 | | | | | | 160x1/4 | 4,34 |
| 150 | | 150 | 2,0 | | | | | | 190x1/4 | 6,66 |

Угольник 45° K/M - K/M

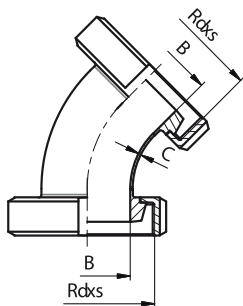
30170
Размеры

| DN | A | B | C | D | E | F | R | L | Rd x s | kg |
|-----|---|-----|-----|---|---|---|---|---|---------|------|
| 10 | | 10 | 1,5 | | | | | | 28x1/8 | 0,20 |
| 15 | | 16 | 1,5 | | | | | | 34x1/8 | 0,25 |
| 20 | | 20 | 1,5 | | | | | | 44x1/6 | 0,40 |
| 25 | | 26 | 1,5 | | | | | | 52x1/6 | 0,56 |
| 32 | | 32 | 1,5 | | | | | | 58x1/6 | 0,67 |
| 40 | | 38 | 1,5 | | | | | | 65x1/6 | 0,81 |
| 50 | | 50 | 1,5 | | | | | | 78x1/6 | 1,12 |
| 65 | | 66 | 2,0 | | | | | | 95x1/6 | 1,88 |
| 80 | | 81 | 2,0 | | | | | | 110x1/4 | 2,43 |
| 100 | | 100 | 2,0 | | | | | | 130x1/4 | 3,44 |
| 125 | | 125 | 2,0 | | | | | | 160x1/4 | 5,43 |
| 150 | | 150 | 2,0 | | | | | | 190x1/4 | 8,01 |

| Угольник 45° Ц-Ц | 30190 | Размеры | | | | | | | | | | |
|------------------|-------|---------|-----|-----|---|------|---|---|---|---|--------|------|
| | | DN | A | B | C | D | E | F | R | L | Rd x s | kg |
| | 10 | | 10 | 1,5 | | 34 | | | | | | 0,07 |
| | 15 | | 16 | 1,5 | | 34 | | | | | | 0,08 |
| | 20 | | 20 | 1,5 | | 34 | | | | | | 0,10 |
| | 25 | | 26 | 1,5 | | 50,5 | | | | | | 0,12 |
| | 32 | | 32 | 1,5 | | 50,5 | | | | | | 0,15 |
| | 40 | | 38 | 1,5 | | 50,5 | | | | | | 0,15 |
| | 50 | | 50 | 1,5 | | 64 | | | | | | 0,20 |
| | 65 | | 66 | 2,0 | | 91 | | | | | | 0,47 |
| | 80 | | 81 | 2,0 | | 106 | | | | | | 0,62 |
| | 100 | | 100 | 2,0 | | 119 | | | | | | 0,72 |
| | | | | | | | | | | | | |

| Угольник 45° С-Ц | 30191 | Размеры | | | | | | | | | | |
|------------------|-------|---------|-----|-----|-----|------|---|---|---|---|--------|------|
| | | DN | A | B | C | D | E | F | R | L | Rd x s | kg |
| | 10 | | 10 | 1,5 | 13 | 34 | | | | | | 0,04 |
| | 15 | | 16 | 1,5 | 19 | 34 | | | | | | 0,05 |
| | 20 | | 20 | 1,5 | 23 | 34 | | | | | | 0,06 |
| | 25 | | 26 | 1,5 | 29 | 50,5 | | | | | | 0,08 |
| | 32 | | 32 | 1,5 | 35 | 50,5 | | | | | | 0,10 |
| | 40 | | 38 | 1,5 | 41 | 50,5 | | | | | | 0,11 |
| | 50 | | 50 | 1,5 | 53 | 64 | | | | | | 0,15 |
| | 65 | | 66 | 2,0 | 70 | 91 | | | | | | 0,34 |
| | 80 | | 81 | 2,0 | 85 | 106 | | | | | | 0,46 |
| | 100 | | 100 | 2,0 | 104 | 119 | | | | | | 0,56 |
| | | | | | | | | | | | | |

Ответвительный штуцер С - С - С

30300

Размеры

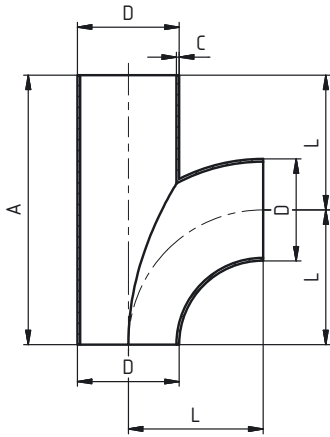

| DN | A | B | C | D | E | F | R | L | Rd x s | kg |
|-----|-----|---|-----|-----|---|---|---|-------|--------|------|
| 15 | 70 | | 1,5 | 18 | | | | 35 | | 0,07 |
| 15 | 70 | | 1,5 | 19 | | | | 35 | | 0,07 |
| 20 | 80 | | 1,5 | 22 | | | | 40 | | 0,08 |
| 20 | 80 | | 1,5 | 23 | | | | 40 | | 0,08 |
| 25 | 100 | | 1,5 | 28 | | | | 50 | | 0,14 |
| 25 | 100 | | 1,5 | 29 | | | | 50 | | 0,14 |
| 32 | 110 | | 1,5 | 34 | | | | 55 | | 0,18 |
| 32 | 110 | | 1,5 | 35 | | | | 55 | | 0,18 |
| 40 | 120 | | 1,5 | 40 | | | | 60 | | 0,23 |
| 40 | 120 | | 1,5 | 41 | | | | 60 | | 0,23 |
| 50 | 140 | | 1,5 | 52 | | | | 70 | | 0,34 |
| 50 | 140 | | 1,5 | 53 | | | | 70 | | 0,34 |
| 65 | 160 | | 2,0 | 70 | | | | 80 | | 0,51 |
| 80 | 180 | | 2,0 | 85 | | | | 90 | | 0,91 |
| 100 | 200 | | 2,0 | 104 | | | | 100 | | 1,21 |
| 125 | 375 | | 2,0 | 129 | | | | 187,5 | | 3,14 |
| 150 | 450 | | 2,0 | 154 | | | | 225 | | 5,38 |

Трубопроводное разветвление С - С - С

30320

Размеры

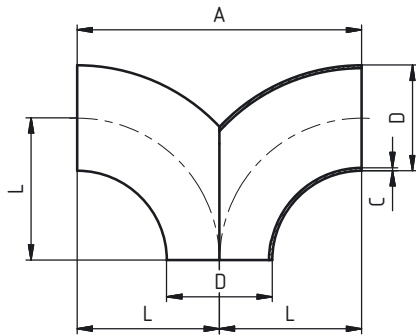

| DN | A | B | C | D | E | F | R | L | Rd x s | kg |
|-----|-----|---|-----|-----|---|---|---|-------|--------|------|
| 15 | 70 | | 1,5 | 18 | | | | 35 | | 0,06 |
| 15 | 70 | | 1,5 | 19 | | | | 35 | | 0,06 |
| 20 | 80 | | 1,5 | 22 | | | | 40 | | 0,08 |
| 20 | 80 | | 1,5 | 23 | | | | 40 | | 0,08 |
| 25 | 100 | | 1,5 | 28 | | | | 50 | | 0,15 |
| 25 | 100 | | 1,5 | 29 | | | | 50 | | 0,15 |
| 32 | 110 | | 1,5 | 34 | | | | 55 | | 0,20 |
| 32 | 110 | | 1,5 | 35 | | | | 55 | | 0,20 |
| 40 | 120 | | 1,5 | 40 | | | | 60 | | 0,26 |
| 40 | 120 | | 1,5 | 41 | | | | 60 | | 0,26 |
| 50 | 140 | | 1,5 | 52 | | | | 70 | | 0,40 |
| 50 | 140 | | 1,5 | 53 | | | | 70 | | 0,40 |
| 65 | 160 | | 2,0 | 70 | | | | 80 | | 0,81 |
| 80 | 180 | | 2,0 | 85 | | | | 90 | | 1,12 |
| 100 | 200 | | 2,0 | 104 | | | | 100 | | 1,52 |
| 125 | 375 | | 2,0 | 129 | | | | 187,5 | | 3,62 |
| 150 | 450 | | 2,0 | 154 | | | | 225 | | 5,22 |

Трубопроводное разветвление Р - Р - Р

30330

Размеры

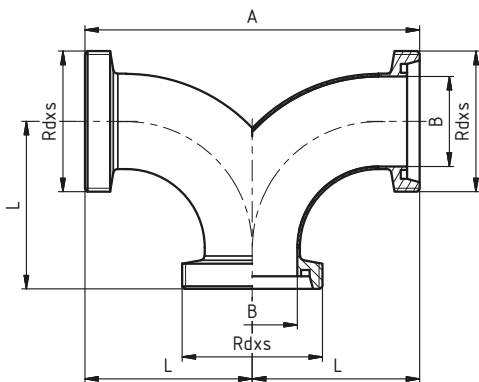

| DN | A | B | C | D | E | F | L | Rd x s | kg |
|-----|-----|-----|-----|---|---|---|-----|---------|-------|
| 25 | 144 | 26 | 1,5 | | | | 72 | 52x1/6 | 0,55 |
| 32 | 154 | 32 | 1,5 | | | | 77 | 58x1/6 | 0,66 |
| 40 | 164 | 38 | 1,5 | | | | 82 | 65x1/6 | 0,82 |
| 50 | 186 | 50 | 1,5 | | | | 93 | 78x1/6 | 1,14 |
| 65 | 210 | 66 | 2,0 | | | | 105 | 95x1/6 | 1,92 |
| 80 | 230 | 81 | 2,0 | | | | 116 | 110x1/4 | 2,83 |
| 100 | 260 | 100 | 2,0 | | | | 130 | 130x1/4 | 3,57 |
| 125 | 446 | 125 | 2,0 | | | | 223 | 160x1/4 | 7,11 |
| 150 | 530 | 150 | 2,0 | | | | 265 | 190x1/4 | 11,15 |

| Угольник 180° С - С | 30340 | Размеры | | | | | | | | | | |
|---------------------|-------|---------|---|-----|-----|---|---|---|---|-----|--------|------|
| | | DN | A | B | C | D | E | F | R | L | Rd x s | kg |
| | 10 | 52 | | 1,5 | 12 | | | | | 26 | | 0,04 |
| | 15 | 70 | | 1,5 | 18 | | | | | 35 | | 0,08 |
| | 20 | 80 | | 1,5 | 22 | | | | | 40 | | 0,08 |
| | 25 | 100 | | 1,5 | 28 | | | | | 50 | | 0,16 |
| | 32 | 112 | | 1,5 | 34 | | | | | 56 | | 0,20 |
| | 40 | 126 | | 1,5 | 40 | | | | | 63 | | 0,40 |
| | 50 | 144 | | 1,5 | 52 | | | | | 72 | | 0,40 |
| | 65 | 170 | | 2,0 | 70 | | | | | 85 | | 0,80 |
| | 80 | 186 | | 2,0 | 85 | | | | | 93 | | 1,12 |
| | 100 | 220 | | 2,0 | 104 | | | | | 110 | | 1,52 |

| Угольник 180° P - P | 30350 | Размеры | | | | | | | | | | |
|---------------------|-------|---------|-----|---|---|---|---|---|-----|---------|---------|------|
| | | DN | A | B | C | D | E | F | R | L | Rd x s | kg |
| | 10 | 52 | 10 | | | | | | | 43 | 28x1/8 | 0,12 |
| | 15 | 70 | 16 | | | | | | | 52 | 34x1/8 | 0,18 |
| | 20 | 80 | 20 | | | | | | | 59 | 44x1/6 | 0,31 |
| | 25 | 100 | 26 | | | | | | | 72 | 52x1/6 | 0,43 |
| | 32 | 112 | 32 | | | | | | | 77 | 58x1/6 | 0,52 |
| | 40 | 126 | 38 | | | | | | | 82 | 65x1/6 | 0,65 |
| | 50 | 144 | 50 | | | | | | | 93 | 78x1/6 | 0,92 |
| | 65 | 170 | 66 | | | | | | | 105 | 95x1/6 | 1,39 |
| | 80 | 186 | 81 | | | | | | | 116 | 110x1/4 | 2,32 |
| | 100 | 220 | 100 | | | | | | | 130 | 130x1/4 | 2,98 |
| 125 | 375 | 125 | | | | | | | 223 | 160x1/4 | 6,09 | |
| 150 | 450 | 150 | | | | | | | 265 | 190x1/4 | 9,37 | |

| Угольник 180° K/M - K/M | 30360 | Размеры | | | | | | | | | | |
|-------------------------|-------|---------|-----|---|---|---|---|---|-------|---------|---------|------|
| | | DN | A | B | C | D | E | F | R | L | Rd x s | kg |
| | 10 | 52 | 10 | | | | | | | 40 | 28x1/8 | 0,23 |
| | 15 | 70 | 16 | | | | | | | 49 | 34x1/8 | 0,31 |
| | 20 | 80 | 20 | | | | | | | 56 | 44x1/6 | 0,48 |
| | 25 | 100 | 26 | | | | | | | 68 | 52x1/6 | 0,54 |
| | 32 | 112 | 32 | | | | | | | 73 | 58x1/6 | 0,83 |
| | 40 | 126 | 38 | | | | | | | 78 | 65x1/6 | 1,02 |
| | 50 | 144 | 50 | | | | | | | 89 | 78x1/6 | 1,44 |
| | 65 | 170 | 66 | | | | | | | 101 | 95x1/6 | 2,31 |
| | 80 | 186 | 81 | | | | | | | 111 | 110x1/4 | 3,32 |
| | 100 | 220 | 100 | | | | | | | 125 | 130x1/4 | 4,65 |
| 125 | 375 | 125 | | | | | | | 214,5 | 160x1/4 | 8,25 | |
| 150 | 450 | 150 | | | | | | | 254 | 190x1/4 | 12,07 | |

Т - деталь С - С - С (короткий)

30400

Размеры

| DN | A | A1 | C | D | E | F | R | L | Rd x s | kg |
|-----|-------|------|-----|-----|---|---|---|---|--------|------|
| 10 | 26 | 8 | 1,5 | 12 | | | | | | 0,02 |
| 10 | 26 | 8 | 1,5 | 13 | | | | | | 0,02 |
| 15 | 35 | 11 | 1,5 | 18 | | | | | | 0,04 |
| 15 | 35 | 11 | 1,5 | 19 | | | | | | 0,04 |
| 20 | 40 | 13 | 1,5 | 22 | | | | | | 0,06 |
| 20 | 40 | 13 | 1,5 | 23 | | | | | | 0,06 |
| 25 | 50 | 16 | 1,5 | 28 | | | | | | 0,10 |
| 25 | 50 | 16 | 1,5 | 29 | | | | | | 0,10 |
| 32 | 55 | 18 | 1,5 | 34 | | | | | | 0,13 |
| 32 | 55 | 18 | 1,5 | 35 | | | | | | 0,13 |
| 40 | 60 | 23 | 1,5 | 40 | | | | | | 0,17 |
| 40 | 60 | 23 | 1,5 | 41 | | | | | | 0,17 |
| 50 | 70 | 29 | 1,5 | 52 | | | | | | 0,26 |
| 50 | 70 | 29 | 1,5 | 53 | | | | | | 0,26 |
| 65 | 80 | 38 | 2,0 | 70 | | | | | | 0,53 |
| 80 | 90 | 45,5 | 2,0 | 85 | | | | | | 0,72 |
| 100 | 100 | 52 | 2,0 | 104 | | | | | | 0,98 |
| 125 | 187,5 | 66,5 | 2,0 | 129 | | | | | | 2,32 |
| 150 | 225 | 79 | 2,0 | 154 | | | | | | 3,32 |

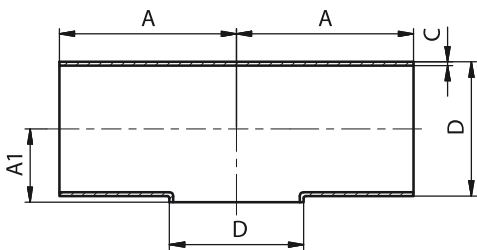

Т - деталь С - С - С (длинный)

30410

Размеры

| DN | A | B | C | D | E | F | R | L | Rd x s | kg |
|-----|-------|---|-----|-----|---|---|---|---|--------|------|
| 10 | 26 | | 1,5 | 12 | | | | | | 0,03 |
| 10 | 26 | | 1,5 | 13 | | | | | | 0,03 |
| 15 | 35 | | 1,5 | 18 | | | | | | 0,06 |
| 15 | 35 | | 1,5 | 19 | | | | | | 0,06 |
| 20 | 40 | | 1,5 | 22 | | | | | | 0,08 |
| 20 | 40 | | 1,5 | 23 | | | | | | 0,08 |
| 25 | 50 | | 1,5 | 28 | | | | | | 0,13 |
| 25 | 50 | | 1,5 | 29 | | | | | | 0,13 |
| 32 | 55 | | 1,5 | 34 | | | | | | 0,18 |
| 32 | 55 | | 1,5 | 35 | | | | | | 0,18 |
| 40 | 60 | | 1,5 | 40 | | | | | | 0,22 |
| 40 | 60 | | 1,5 | 41 | | | | | | 0,22 |
| 50 | 70 | | 1,5 | 52 | | | | | | 0,34 |
| 50 | 70 | | 1,5 | 53 | | | | | | 0,34 |
| 65 | 80 | | 2,0 | 70 | | | | | | 0,67 |
| 80 | 90 | | 2,0 | 85 | | | | | | 0,91 |
| 100 | 100 | | 2,0 | 104 | | | | | | 1,21 |
| 125 | 187,5 | | 2,0 | 129 | | | | | | 3,08 |
| 150 | 225 | | 2,0 | 154 | | | | | | 4,43 |

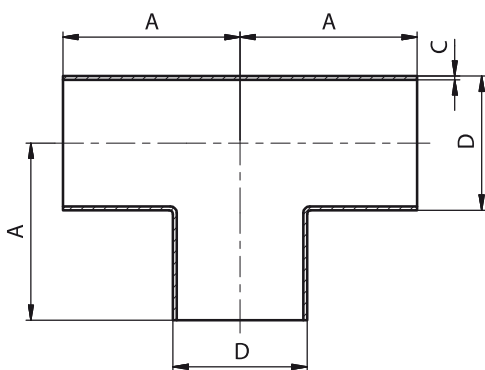

T - деталь С - С - С (редукционная)

30430

Размеры

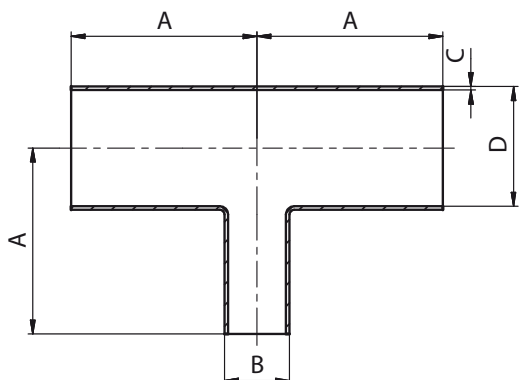

| DN | A | B | C | D | | | DN | A | B | C | D | E | kg |
|-------|----|----|-----|----|--|--|---------|-------|-----|---|-----|---|----|
| 15/10 | 35 | 13 | 1,5 | 19 | | | 65/32 | 80 | 35 | 2 | 70 | | |
| 20/10 | 40 | 13 | 1,5 | 23 | | | 65/40 | 80 | 41 | 2 | 70 | | |
| 20/15 | 40 | 19 | 1,5 | 23 | | | 65/50 | 80 | 53 | 2 | 70 | | |
| 25/10 | 50 | 13 | 1,5 | 29 | | | 80/15 | 90 | 19 | 2 | 85 | | |
| 25/15 | 50 | 19 | 1,5 | 29 | | | 80/25 | 90 | 29 | 2 | 85 | | |
| 25/20 | 50 | 23 | 1,5 | 29 | | | 80/32 | 90 | 35 | 2 | 85 | | |
| 32/10 | 55 | 13 | 1,5 | 35 | | | 80/40 | 90 | 41 | 2 | 85 | | |
| 32/15 | 55 | 19 | 1,5 | 35 | | | 80/50 | 90 | 53 | 2 | 85 | | |
| 32/20 | 55 | 23 | 1,5 | 35 | | | 80/65 | 90 | 70 | 2 | 85 | | |
| 32/25 | 55 | 29 | 1,5 | 35 | | | 100/25 | 100 | 29 | 2 | 104 | | |
| 40/10 | 60 | 13 | 1,5 | 41 | | | 100/32 | 100 | 35 | 2 | 104 | | |
| 40/15 | 60 | 19 | 1,5 | 41 | | | 100/40 | 100 | 41 | 2 | 104 | | |
| 40/20 | 60 | 23 | 1,5 | 41 | | | 100/50 | 100 | 53 | 2 | 104 | | |
| 40/25 | 60 | 29 | 1,5 | 41 | | | 100/65 | 100 | 70 | 2 | 104 | | |
| 40/32 | 60 | 35 | 1,5 | 41 | | | 100/80 | 100 | 85 | 2 | 104 | | |
| 50/10 | 70 | 13 | 1,5 | 53 | | | 125/65 | 187,5 | 70 | 2 | 125 | | |
| 50/15 | 70 | 19 | 1,5 | 53 | | | 125/80 | 187,5 | 85 | 2 | 125 | | |
| 50/20 | 70 | 23 | 1,5 | 53 | | | 150/40 | 225 | 41 | 2 | 150 | | |
| 50/25 | 70 | 29 | 1,5 | 53 | | | 150/80 | 225 | 85 | 2 | 150 | | |
| 50/32 | 70 | 35 | 1,5 | 53 | | | 150/100 | 225 | 104 | 2 | 150 | | |
| 50/40 | 70 | 41 | 1,5 | 53 | | | 150/125 | 225 | 129 | 2 | 150 | | |
| 65/15 | 80 | 19 | 2 | 70 | | | | | | | | | |
| 65/20 | 80 | 23 | 2 | 70 | | | | | | | | | |
| 65/25 | 80 | 29 | 2 | 70 | | | | | | | | | |

T - деталь С - С - С (редукционная)

30440

Размеры

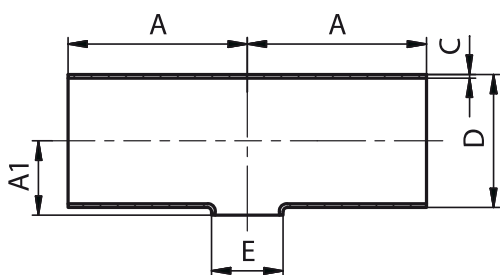

| DN | A | A1 | C | D | E | kg | DN | A | A1 | C | D | E | kg |
|-------|----|----|-----|----|----|------|---------|-------|------|-----|-----|-----|------|
| 15/10 | 35 | 11 | 1,5 | 19 | 13 | 0,04 | 65/32 | 80 | 38 | 2,0 | 70 | 35 | 0,49 |
| 20/10 | 40 | 13 | 1,5 | 23 | 13 | 0,07 | 65/40 | 80 | 38 | 2,0 | 70 | 41 | 0,51 |
| 20/15 | 40 | 13 | 1,5 | 23 | 19 | 0,07 | 65/50 | 80 | 38 | 2,0 | 70 | 53 | 0,51 |
| 25/10 | 50 | 16 | 1,5 | 29 | 13 | 0,09 | 80/40 | 90 | 46 | 2,0 | 85 | 41 | 0,70 |
| 25/15 | 50 | 16 | 1,5 | 29 | 19 | 0,10 | 80/50 | 90 | 46 | 2,0 | 85 | 53 | 0,68 |
| 25/20 | 50 | 16 | 1,5 | 29 | 23 | 0,14 | 80/65 | 90 | 46 | 2,0 | 85 | 70 | 0,81 |
| 32/10 | 55 | 19 | 1,5 | 35 | 13 | 0,14 | 100/50 | 100 | 55 | 2,0 | 104 | 53 | 0,99 |
| 32/15 | 55 | 19 | 1,5 | 35 | 19 | 0,14 | 100/65 | 100 | 55 | 2,0 | 104 | 70 | 0,96 |
| 32/20 | 55 | 19 | 1,5 | 35 | 23 | 0,14 | 100/80 | 100 | 55 | 2,0 | 104 | 85 | 0,92 |
| 32/25 | 55 | 19 | 1,5 | 35 | 29 | 0,14 | 125/65 | 187,5 | 66,5 | 2,0 | 129 | 70 | 2,25 |
| 40/15 | 60 | 22 | 1,5 | 41 | 19 | 0,16 | 125/80 | 187,5 | 66,5 | 2,0 | 129 | 85 | 2,18 |
| 40/20 | 60 | 22 | 1,5 | 41 | 23 | 0,16 | 125/100 | 187,5 | 66,5 | 2,0 | 129 | 104 | 2,08 |
| 40/25 | 60 | 22 | 1,5 | 41 | 29 | 0,17 | 150/80 | 225 | 79 | 2,0 | 154 | 85 | 3,25 |
| 40/32 | 60 | 22 | 1,5 | 41 | 35 | 0,17 | 150/100 | 225 | 79 | 2,0 | 154 | 104 | 3,16 |
| 50/20 | 70 | 28 | 1,5 | 53 | 23 | 0,25 | 150/125 | 225 | 79 | 2,0 | 154 | 129 | 3,03 |
| 50/25 | 70 | 28 | 1,5 | 53 | 29 | 0,26 | | | | | | | |
| 50/32 | 70 | 28 | 1,5 | 53 | 35 | 0,26 | | | | | | | |
| 50/40 | 70 | 28 | 1,5 | 53 | 41 | 0,27 | | | | | | | |
| 65/25 | 80 | 38 | 2,0 | 70 | 29 | 0,46 | | | | | | | |

T - деталь P - P - P

30450

Размеры

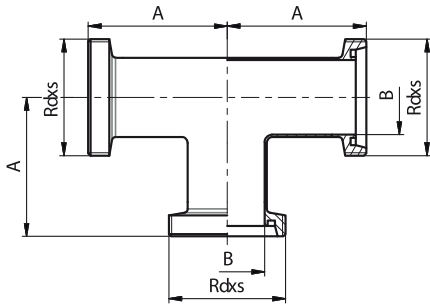

| DN | A | B | C | D | E | F | R | L | Rd x s | kg |
|-----|-----|-----|---|---|---|---|---|---|---------|-------|
| 10 | 43 | 10 | | | | | | | 28x1/8 | 0,16 |
| 15 | 52 | 16 | | | | | | | 34x1/8 | 0,23 |
| 20 | 59 | 20 | | | | | | | 44x1/6 | 0,40 |
| 25 | 72 | 26 | | | | | | | 52x1/6 | 0,53 |
| 32 | 77 | 32 | | | | | | | 58x1/6 | 0,64 |
| 40 | 82 | 38 | | | | | | | 65x1/6 | 0,79 |
| 50 | 93 | 50 | | | | | | | 78x1/6 | 1,08 |
| 65 | 105 | 66 | | | | | | | 95x1/6 | 1,78 |
| 80 | 116 | 81 | | | | | | | 110x1/4 | 2,62 |
| 100 | 130 | 100 | | | | | | | 130x1/4 | 3,26 |
| 125 | 223 | 125 | | | | | | | 160x1/4 | 6,57 |
| 150 | 265 | 150 | | | | | | | 190x1/4 | 10,38 |

T - деталь P - P - K/M

30460

Размеры

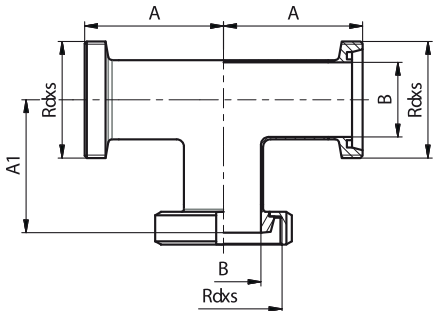

| DN | A | A1 | B | D | E | F | R | L | Rd x s | kg |
|-----|-----|-------|-----|---|---|---|---|---|---------|------|
| 10 | 43 | 40 | 10 | | | | | | 28x1/8 | 0,21 |
| 15 | 52 | 49 | 16 | | | | | | 34x1/8 | 0,29 |
| 20 | 59 | 56 | 20 | | | | | | 44x1/6 | 0,48 |
| 25 | 72 | 68 | 26 | | | | | | 52x1/6 | 0,62 |
| 32 | 77 | 73 | 32 | | | | | | 58x1/6 | 0,80 |
| 40 | 82 | 78 | 38 | | | | | | 65x1/6 | 0,97 |
| 50 | 93 | 89 | 50 | | | | | | 78x1/6 | 1,35 |
| 65 | 105 | 101 | 66 | | | | | | 95x1/6 | 2,24 |
| 80 | 116 | 111 | 81 | | | | | | 110x1/4 | 3,11 |
| 100 | 130 | 125 | 100 | | | | | | 130x1/4 | 4,10 |
| 125 | 223 | 214,5 | 125 | | | | | | 160x1/4 | 7,65 |
| 150 | 265 | 254 | 150 | | | | | | 190x1/4 | 9,34 |

T - деталь P - K/M - P

30470

Размеры

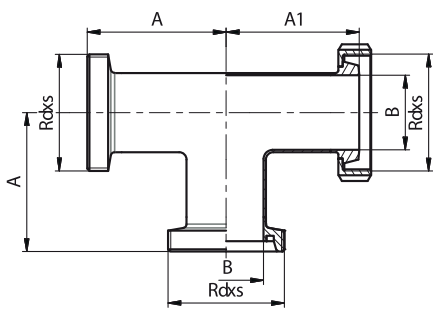

| DN | A | A1 | B | D | E | F | R | L | Rd x s | kg |
|-----|-----|-------|-----|---|---|---|---|---|---------|------|
| 10 | 43 | 40 | 10 | | | | | | 28x1/8 | 0,21 |
| 15 | 52 | 49 | 16 | | | | | | 34x1/8 | 0,29 |
| 20 | 59 | 56 | 20 | | | | | | 44x1/6 | 0,48 |
| 25 | 72 | 68 | 26 | | | | | | 52x1/6 | 0,62 |
| 32 | 77 | 73 | 32 | | | | | | 58x1/6 | 0,80 |
| 40 | 82 | 78 | 38 | | | | | | 65x1/6 | 0,97 |
| 50 | 93 | 89 | 50 | | | | | | 78x1/6 | 1,35 |
| 65 | 105 | 101 | 66 | | | | | | 95x1/6 | 2,24 |
| 80 | 116 | 111 | 81 | | | | | | 110x1/4 | 3,11 |
| 100 | 130 | 125 | 100 | | | | | | 130x1/4 | 4,10 |
| 125 | 223 | 214,5 | 125 | | | | | | 160x1/4 | 7,65 |
| 150 | 265 | 254 | 150 | | | | | | 190x1/4 | 9,34 |

T - деталь P - K/M - K/M

30480

Размеры

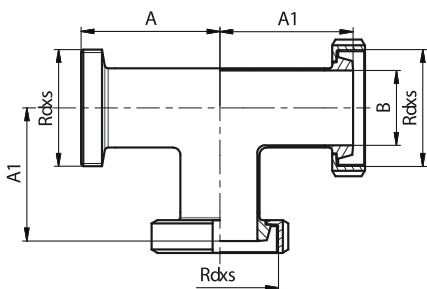

| DN | A | A1 | B | D | E | F | R | L | Rd x s | kg |
|-----|-----|-------|-----|---|---|---|---|---|---------|-------|
| 10 | 43 | 40 | 10 | | | | | | 28x1/8 | 0,27 |
| 15 | 52 | 49 | 16 | | | | | | 34x1/8 | 0,35 |
| 20 | 59 | 56 | 20 | | | | | | 44x1/6 | 0,56 |
| 25 | 72 | 68 | 26 | | | | | | 52x1/6 | 0,79 |
| 32 | 77 | 73 | 32 | | | | | | 58x1/6 | 0,95 |
| 40 | 82 | 78 | 38 | | | | | | 65x1/6 | 1,16 |
| 50 | 93 | 89 | 50 | | | | | | 78x1/6 | 1,60 |
| 65 | 105 | 101 | 66 | | | | | | 95x1/6 | 2,70 |
| 80 | 116 | 111 | 81 | | | | | | 110x1/4 | 3,61 |
| 100 | 130 | 125 | 100 | | | | | | 130x1/4 | 4,93 |
| 125 | 223 | 214,5 | 125 | | | | | | 160x1/4 | 8,73 |
| 150 | 265 | 254 | 150 | | | | | | 190x1/4 | 13,06 |

Т - деталь К/М - К/М - Р

30490

Размеры

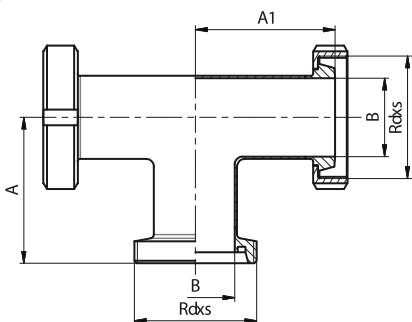

| DN | A | A1 | B | D | E | F | R | L | Rd x s | kg |
|-----|-----|-------|-----|---|---|---|---|---|---------|-------|
| 10 | 43 | 40 | 10 | | | | | | 28x1/8 | 0,27 |
| 15 | 52 | 49 | 16 | | | | | | 34x1/8 | 0,35 |
| 20 | 59 | 56 | 20 | | | | | | 44x1/6 | 0,56 |
| 25 | 72 | 68 | 26 | | | | | | 52x1/6 | 0,79 |
| 32 | 77 | 73 | 32 | | | | | | 58x1/6 | 0,95 |
| 40 | 82 | 78 | 38 | | | | | | 65x1/6 | 1,16 |
| 50 | 93 | 89 | 50 | | | | | | 78x1/6 | 1,60 |
| 65 | 105 | 101 | 66 | | | | | | 95x1/6 | 2,70 |
| 80 | 115 | 111 | 81 | | | | | | 110x1/4 | 3,61 |
| 100 | 130 | 125 | 100 | | | | | | 130x1/4 | 4,93 |
| 125 | 223 | 214,5 | 125 | | | | | | 160x1/4 | 8,73 |
| 150 | 265 | 254 | 150 | | | | | | 190x1/4 | 13,06 |

Т - деталь К/М - К/М - К/М

30500

Размеры

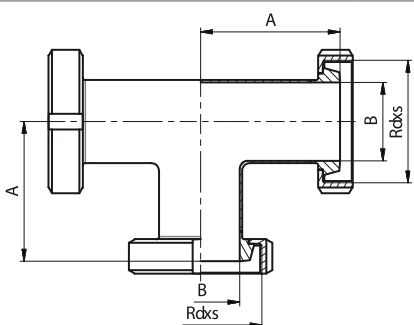

| DN | A | B | C | D | E | F | R | L | Rd x s | kg |
|-----|-------|-----|---|---|---|---|---|---|---------|-------|
| 10 | 40 | 10 | | | | | | | 28x1/8 | 0,32 |
| 15 | 49 | 16 | | | | | | | 34x1/8 | 0,41 |
| 20 | 56 | 20 | | | | | | | 44x1/6 | 0,64 |
| 25 | 68 | 26 | | | | | | | 52x1/6 | 0,92 |
| 32 | 73 | 32 | | | | | | | 58x1/6 | 1,11 |
| 40 | 78 | 38 | | | | | | | 65x1/6 | 1,34 |
| 50 | 89 | 50 | | | | | | | 78x1/6 | 1,86 |
| 65 | 101 | 66 | | | | | | | 95x1/6 | 3,17 |
| 80 | 111 | 81 | | | | | | | 110x1/4 | 4,11 |
| 100 | 125 | 100 | | | | | | | 130x1/4 | 5,76 |
| 125 | 214,5 | 125 | | | | | | | 160x1/4 | 9,81 |
| 150 | 254 | 150 | | | | | | | 190x1/4 | 14,41 |

Т - деталь длинная Ц - Ц - Ц (длинный)

30520

Размеры

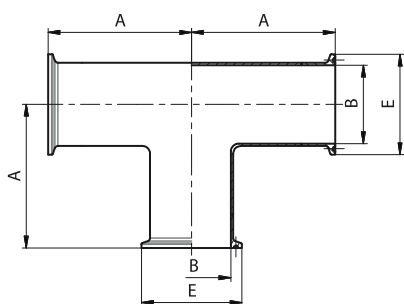

| DN | A | B | C | D | E | F | R | L | Rd x s | kg |
|-----|-------|-----|---|---|------|---|---|---|--------|------|
| 10 | 44 | 10 | | | 34 | | | | | 0,13 |
| 15 | 53 | 16 | | | 34 | | | | | 0,15 |
| 20 | 58 | 20 | | | 50,5 | | | | | 0,16 |
| 25 | 71,5 | 26 | | | 50,5 | | | | | 0,34 |
| 32 | 76,5 | 32 | | | 50,5 | | | | | 0,40 |
| 40 | 81,5 | 38 | | | 50,5 | | | | | 0,40 |
| 50 | 91,5 | 50 | | | 64 | | | | | 0,54 |
| 65 | 108 | 66 | | | 91 | | | | | 1,24 |
| 80 | 118 | 81 | | | 106 | | | | | 1,59 |
| 100 | 128 | 100 | | | 119 | | | | | 1,88 |
| 125 | 215,5 | 125 | | | 155 | | | | | 4,64 |
| 150 | 253 | 150 | | | 183 | | | | | 6,53 |

Т - деталь Ц - Ц - Ц (короткий)

30521

Размеры

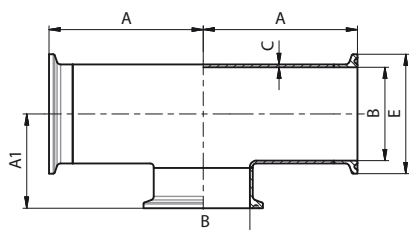

| DN | A | A1 | B | C | E | F | R | L | Rd x s | kg |
|-----|-------|------|-----|-----|------|---|---|---|--------|------|
| 10 | 38,7 | 26 | 10 | 1,5 | 34 | | | | | 0,13 |
| 15 | 47,7 | 29 | 16 | 1,5 | 34 | | | | | 0,15 |
| 20 | 52,7 | 31 | 20 | 1,5 | 50,5 | | | | | 0,16 |
| 25 | 62,7 | 37,5 | 26 | 1,5 | 50,5 | | | | | 0,34 |
| 32 | 67,7 | 39,5 | 32 | 1,5 | 50,5 | | | | | 0,40 |
| 40 | 72,7 | 44,5 | 38 | 1,5 | 50,5 | | | | | 0,40 |
| 50 | 82,7 | 50,5 | 50 | 1,5 | 64 | | | | | 0,54 |
| 65 | 92,7 | 66 | 66 | 2,0 | 91 | | | | | 1,24 |
| 80 | 102,7 | 73,5 | 81 | 2,0 | 106 | | | | | 1,59 |
| 100 | 112,7 | 80 | 100 | 2,0 | 119 | | | | | 1,88 |

T-деталь С - Ц - С (короткий)

30522

Размеры

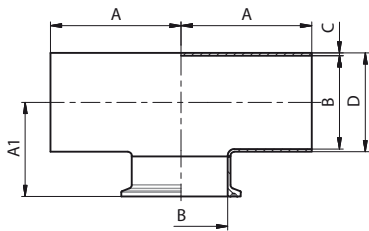

| DN | A | A1 | B | C | D | E | F | L | Rd x s | kg |
|-----|-----|------|-----|-----|-----|------|---|---|--------|------|
| 10 | 26 | 26 | 10 | 1,5 | 13 | 34 | | | | 0,07 |
| 15 | 35 | 29 | 16 | 1,5 | 19 | 34 | | | | 0,09 |
| 20 | 40 | 31 | 20 | 1,5 | 23 | 50,5 | | | | 0,10 |
| 25 | 50 | 37,5 | 26 | 1,5 | 29 | 50,5 | | | | 0,28 |
| 32 | 55 | 39,5 | 32 | 1,5 | 35 | 50,5 | | | | 0,34 |
| 40 | 60 | 44,5 | 38 | 1,5 | 41 | 50,5 | | | | 0,34 |
| 50 | 70 | 50,5 | 50 | 1,5 | 53 | 64 | | | | 0,48 |
| 65 | 80 | 66 | 66 | 2,0 | 70 | 91 | | | | 1,18 |
| 80 | 90 | 73,5 | 81 | 2,0 | 85 | 106 | | | | 1,53 |
| 100 | 100 | 80 | 100 | 2,0 | 104 | 119 | | | | 1,82 |

Крест С - С - С - С (короткий)

30540

Размеры

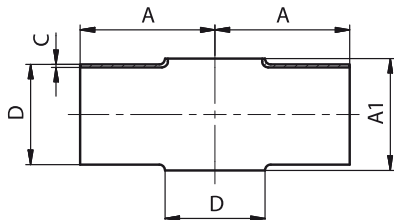

| DN | A | A1 | C | D | E | F | R | L | Rd x s | kg |
|-----|-----|-----|-----|-----|---|---|---|---|--------|------|
| 25 | 50 | 30 | 1,5 | 28 | | | | | | 0,09 |
| 25 | 50 | 30 | 1,5 | 29 | | | | | | 0,09 |
| 32 | 55 | 36 | 1,5 | 34 | | | | | | 0,13 |
| 32 | 55 | 36 | 1,5 | 35 | | | | | | 0,13 |
| 40 | 60 | 44 | 1,5 | 40 | | | | | | 0,17 |
| 40 | 60 | 44 | 1,5 | 41 | | | | | | 0,17 |
| 50 | 70 | 58 | 1,5 | 52 | | | | | | 0,25 |
| 50 | 70 | 58 | 1,5 | 53 | | | | | | 0,25 |
| 65 | 80 | 76 | 2,0 | 70 | | | | | | 0,51 |
| 80 | 90 | 91 | 2,0 | 85 | | | | | | 0,69 |
| 100 | 100 | 110 | 2,0 | 104 | | | | | | 0,93 |

Крест редукционный короткий
С - С - С - С

30550

Dimensions

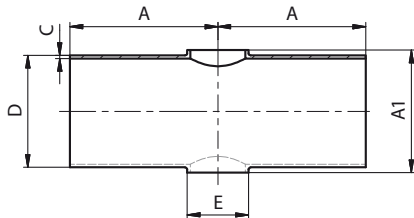

| DN | A | A1 | C | D | E | kg | DN | A | A1 | C | D | E | kg |
|-------|----|----|-----|----|----|------|---------|-------|-----|-----|-----|-----|------|
| 15/10 | 35 | 22 | 1,5 | 19 | 13 | 0,03 | 50/40 | 70 | 56 | 1,5 | 53 | 41 | 0,23 |
| 20/10 | 40 | 26 | 1,5 | 23 | 13 | 0,05 | 65/25 | 80 | 76 | 2,0 | 70 | 29 | 0,41 |
| 20/15 | 40 | 26 | 1,5 | 23 | 19 | 0,05 | 65/32 | 80 | 76 | 2,0 | 70 | 35 | 0,44 |
| 25/10 | 50 | 32 | 1,5 | 29 | 13 | 0,07 | 65/40 | 80 | 76 | 2,0 | 70 | 41 | 0,46 |
| 25/15 | 50 | 32 | 1,5 | 29 | 19 | 0,09 | 65/50 | 80 | 76 | 2,0 | 70 | 53 | 0,46 |
| 25/20 | 50 | 32 | 1,5 | 29 | 23 | 0,09 | 80/40 | 90 | 92 | 2,0 | 85 | 41 | 0,64 |
| 32/10 | 55 | 38 | 1,5 | 35 | 13 | 0,10 | 80/50 | 90 | 92 | 2,0 | 85 | 53 | 0,62 |
| 32/15 | 55 | 38 | 1,5 | 35 | 19 | 0,10 | 80/65 | 90 | 92 | 2,0 | 85 | 70 | 0,75 |
| 32/20 | 55 | 38 | 1,5 | 35 | 23 | 0,09 | 100/50 | 100 | 110 | 2,0 | 104 | 53 | 0,91 |
| 32/25 | 55 | 38 | 1,5 | 35 | 29 | 0,09 | 100/65 | 100 | 110 | 2,0 | 104 | 70 | 0,89 |
| 40/15 | 60 | 44 | 1,5 | 41 | 19 | 0,13 | 100/80 | 100 | 110 | 2,0 | 104 | 85 | 0,81 |
| 40/20 | 60 | 44 | 1,5 | 41 | 23 | 0,13 | 125/65 | 187,5 | 133 | 2,0 | 129 | 70 | 2,19 |
| 40/25 | 60 | 44 | 1,5 | 41 | 29 | 0,14 | 125/80 | 187,5 | 133 | 2,0 | 129 | 85 | 2,01 |
| 40/32 | 60 | 44 | 1,5 | 41 | 35 | 0,14 | 125/100 | 187,5 | 133 | 2,0 | 129 | 104 | 1,85 |
| 50/20 | 70 | 56 | 1,5 | 53 | 23 | 0,22 | 150/80 | 225 | 158 | 2,0 | 154 | 85 | 3,03 |
| 50/25 | 70 | 56 | 1,5 | 53 | 29 | 0,23 | 150/100 | 225 | 158 | 2,0 | 154 | 104 | 2,85 |
| 50/32 | 70 | 56 | 1,5 | 53 | 35 | 0,23 | 150/125 | 225 | 158 | 2,0 | 154 | 129 | 2,63 |

Крест С-С-С-С (длинный)

30560

Размеры

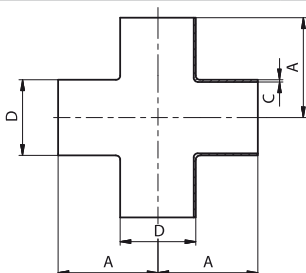

| DN | A | B | C | D | E | F | R | L | Rd x s | kg |
|-----|-----|---|-----|-----|---|---|---|---|--------|------|
| 25 | 50 | | 1,5 | 28 | | | | | | 0,18 |
| 25 | 50 | | 1,5 | 29 | | | | | | 0,18 |
| 32 | 55 | | 1,5 | 34 | | | | | | 0,22 |
| 32 | 55 | | 1,5 | 35 | | | | | | 0,22 |
| 40 | 60 | | 1,5 | 40 | | | | | | 0,28 |
| 40 | 60 | | 1,5 | 41 | | | | | | 0,28 |
| 50 | 70 | | 1,5 | 52 | | | | | | 0,42 |
| 50 | 70 | | 1,5 | 53 | | | | | | 0,42 |
| 65 | 80 | | 2,0 | 70 | | | | | | 0,80 |
| 80 | 90 | | 2,0 | 85 | | | | | | 1,01 |
| 100 | 100 | | 2,0 | 104 | | | | | | 1,39 |

Футорка концентрическая С - С

30600

Размеры

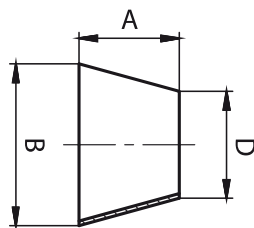

| DN | A | B | D | kg |
|-------|----|----|----|------|
| 15/10 | 11 | 19 | 13 | 0,01 |
| 20/10 | 18 | 23 | 13 | 0,01 |
| 20/15 | 7 | 23 | 19 | 0,01 |
| 25/15 | 18 | 29 | 19 | 0,02 |
| 25/20 | 11 | 29 | 23 | 0,01 |
| 32/20 | 22 | 35 | 23 | 0,02 |
| 32/25 | 11 | 35 | 29 | 0,01 |
| 40/20 | 33 | 41 | 23 | 0,02 |
| 40/25 | 22 | 41 | 29 | 0,03 |
| 40/32 | 11 | 41 | 35 | 0,01 |
| 50/25 | 44 | 53 | 29 | 0,06 |
| 50/32 | 33 | 53 | 35 | 0,05 |
| 50/40 | 23 | 53 | 41 | 0,04 |

| DN | A | B | D | kg |
|---------|-----|-----|-----|------|
| 65/40 | 52 | 70 | 41 | 0,12 |
| 65/50 | 30 | 70 | 53 | 0,08 |
| 80/50 | 56 | 85 | 53 | 0,20 |
| 80/65 | 27 | 85 | 70 | 0,11 |
| 100/65 | 60 | 104 | 70 | 0,26 |
| 100/80 | 35 | 104 | 85 | 0,16 |
| 125/80 | 79 | 129 | 85 | 0,42 |
| 125/100 | 45 | 129 | 104 | 0,27 |
| 150/100 | 90 | 154 | 104 | 0,60 |
| 150/125 | 45 | 154 | 129 | 0,33 |
| 200/150 | 90 | 204 | 154 | 0,80 |
| 250/150 | 297 | 253 | 154 | 2,90 |

Футорка концентрическая Ц-Ц

30609

Размеры

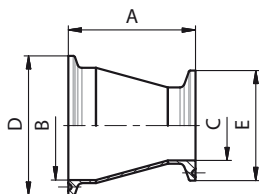

| DN | A | B | C | D | E | F | R | L | Rd x s | kg |
|--------|------|-----|----|------|------|---|---|---|--------|------|
| 32/25 | 36,5 | 32 | 26 | 50,5 | 50,5 | | | | | 0,11 |
| 40/25 | 48 | 38 | 26 | 50,5 | 50,5 | | | | | 0,11 |
| 40/32 | 37 | 38 | 32 | 50,5 | 50,5 | | | | | 0,11 |
| 50/25 | 70 | 50 | 26 | 64 | 50,5 | | | | | 0,14 |
| 50/32 | 59 | 50 | 32 | 64 | 50,5 | | | | | 0,15 |
| 50/40 | 48,5 | 50 | 38 | 64 | 50,5 | | | | | 0,13 |
| 65/40 | 77,5 | 66 | 38 | 91 | 50,5 | | | | | 0,31 |
| 65/50 | 55,5 | 66 | 50 | 91 | 64 | | | | | 0,18 |
| 80/50 | 84 | 81 | 50 | 106 | 64 | | | | | 0,40 |
| 80/65 | 53 | 81 | 66 | 106 | 91 | | | | | 0,39 |
| 100/65 | 87 | 100 | 66 | 119 | 91 | | | | | 0,55 |
| 100/80 | 60,5 | 100 | 81 | 119 | 106 | | | | | 0,48 |

Футорка эксцентричная С - С

30610

Размеры

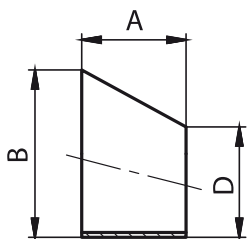

| DN | A | B | C | D | E | F | R | L | Rd x s | kg |
|--------|------|-----|---|----|---|---|---|---|--------|------|
| 32/25 | 16,5 | 35 | | 29 | | | | | | 0,02 |
| 40/25 | 33 | 41 | | 29 | | | | | | 0,03 |
| 40/32 | 16,5 | 41 | | 35 | | | | | | 0,02 |
| 50/25 | 44 | 53 | | 29 | | | | | | 0,05 |
| 50/32 | 33 | 53 | | 35 | | | | | | 0,05 |
| 50/40 | 33 | 53 | | 41 | | | | | | 0,04 |
| 65/40 | 51 | 70 | | 41 | | | | | | 0,14 |
| 65/50 | 44 | 70 | | 53 | | | | | | 0,09 |
| 80/50 | 56 | 85 | | 53 | | | | | | 0,19 |
| 80/65 | 41,2 | 85 | | 70 | | | | | | 0,10 |
| 100/65 | 61 | 104 | | 70 | | | | | | 0,26 |
| 100/80 | 52,5 | 104 | | 85 | | | | | | 0,16 |

Футорка эксцентричная Ц-Ц

30619

Размеры

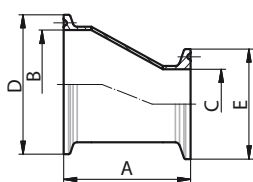

| DN | A | B | C | D | E | F | R | L | Rd x s | kg |
|--------|------|-----|----|------|------|---|---|---|--------|------|
| 32/25 | 41,9 | 32 | 26 | 50,5 | 50,5 | | | | | 0,11 |
| 40/25 | 58,4 | 38 | 26 | 50,5 | 50,5 | | | | | 0,11 |
| 40/32 | 41,9 | 38 | 32 | 50,5 | 50,5 | | | | | 0,11 |
| 50/25 | 69,4 | 50 | 26 | 64 | 50,5 | | | | | 0,14 |
| 50/32 | 58,4 | 50 | 32 | 64 | 50,5 | | | | | 0,15 |
| 50/40 | 58,4 | 50 | 38 | 64 | 50,5 | | | | | 0,13 |
| 65/40 | 76,4 | 66 | 38 | 91 | 50,5 | | | | | 0,31 |
| 65/50 | 69,4 | 66 | 50 | 91 | 64 | | | | | 0,18 |
| 80/50 | 81,4 | 81 | 50 | 106 | 64 | | | | | 0,40 |
| 80/65 | 66,6 | 81 | 66 | 106 | 91 | | | | | 0,39 |
| 100/65 | 89,5 | 100 | 66 | 119 | 91 | | | | | 0,55 |
| 100/80 | 81 | 100 | 81 | 119 | 106 | | | | | 0,48 |

Футорка концентрическая С - С
(длинная)

30620

Размеры

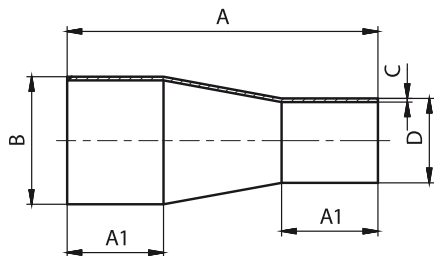

| DN | A | A1 | B | C | D | F | R | L | Rd x s | kg |
|--------|-----|----|-----|-----|----|---|---|---|--------|------|
| 15/10 | 45 | 18 | 18 | 1,5 | 12 | | | | | 0,02 |
| 20/10 | 63 | 18 | 22 | 1,5 | 12 | | | | | 0,04 |
| 20/15 | 60 | 20 | 22 | 1,5 | 18 | | | | | 0,04 |
| 25/15 | 60 | 20 | 28 | 1,5 | 18 | | | | | 0,05 |
| 25/20 | 60 | 20 | 28 | 1,5 | 22 | | | | | 0,05 |
| 32/25 | 80 | 30 | 34 | 1,5 | 28 | | | | | 0,09 |
| 40/25 | 102 | 35 | 40 | 1,5 | 28 | | | | | 0,12 |
| 40/32 | 88 | 35 | 40 | 1,5 | 34 | | | | | 0,12 |
| 50/25 | 115 | 40 | 52 | 1,5 | 28 | | | | | 0,17 |
| 50/32 | 129 | 40 | 52 | 1,5 | 34 | | | | | 0,20 |
| 50/40 | 113 | 40 | 52 | 1,5 | 40 | | | | | 0,19 |
| 65/32 | 125 | 40 | 70 | 2,0 | 34 | | | | | 0,24 |
| 65/40 | 120 | 40 | 70 | 2,0 | 40 | | | | | 0,33 |
| 65/50 | 130 | 40 | 70 | 2,0 | 52 | | | | | 0,39 |
| 80/40 | 140 | 40 | 85 | 2,0 | 40 | | | | | 0,44 |
| 80/50 | 125 | 40 | 85 | 2,0 | 52 | | | | | 0,43 |
| 80/65 | 120 | 40 | 85 | 2,0 | 70 | | | | | 0,46 |
| 100/50 | 160 | 40 | 104 | 2,0 | 52 | | | | | 0,63 |
| 100/65 | 127 | 40 | 104 | 2,0 | 70 | | | | | 0,56 |
| 100/85 | 120 | 40 | 104 | 2,0 | 85 | | | | | 0,56 |

Футорка эксцентричная С - С,
(длинная)

30630

Размеры

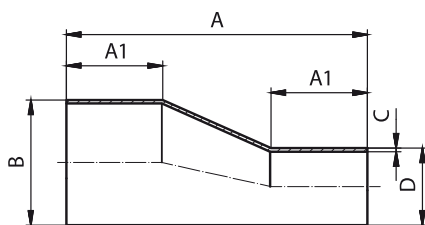

| DN | A | A1 | B | C | D | F | R | L | Rd x s | kg |
|--------|-----|----|-----|-----|----|---|---|---|--------|------|
| 20/15 | 60 | 20 | 22 | 1,5 | 18 | | | | | 0,04 |
| 25/15 | 60 | 20 | 28 | 1,5 | 18 | | | | | 0,05 |
| 25/20 | 60 | 20 | 28 | 1,5 | 22 | | | | | 0,05 |
| 32/25 | 100 | 40 | 34 | 1,5 | 28 | | | | | 0,11 |
| 40/25 | 100 | 40 | 40 | 1,5 | 28 | | | | | 0,13 |
| 40/32 | 100 | 40 | 40 | 1,5 | 34 | | | | | 0,13 |
| 50/25 | 130 | 40 | 52 | 1,5 | 28 | | | | | 0,20 |
| 50/32 | 125 | 40 | 52 | 1,5 | 34 | | | | | 0,20 |
| 50/40 | 100 | 40 | 52 | 1,5 | 40 | | | | | 0,17 |
| 65/40 | 140 | 40 | 70 | 2,0 | 40 | | | | | 0,39 |
| 65/50 | 125 | 40 | 70 | 2,0 | 52 | | | | | 0,38 |
| 80/50 | 130 | 40 | 85 | 2,0 | 52 | | | | | 0,46 |
| 80/65 | 110 | 40 | 85 | 2,0 | 70 | | | | | 0,43 |
| 100/65 | 155 | 40 | 104 | 2,0 | 70 | | | | | 0,70 |
| 100/85 | 130 | 40 | 104 | 2,0 | 85 | | | | | 0,62 |
| 80/50 | 125 | 40 | 85 | 2,0 | 52 | | | | | 0,43 |
| 80/65 | 120 | 40 | 85 | 2,0 | 70 | | | | | 0,46 |
| 100/50 | 160 | 40 | 104 | 2,0 | 52 | | | | | 0,63 |
| 100/65 | 127 | 40 | 104 | 2,0 | 70 | | | | | 0,56 |
| 100/85 | 120 | 40 | 104 | 2,0 | 85 | | | | | 0,56 |

| Угольник 90° С - С, СМС | 31010 | Размеры | | | | | | | | | | |
|-------------------------|-------|---------|---|------|-------|---|---|---|--------|---|--------|------|
| | SMS | DN | A | B | C | D | E | F | r | L | Rd x s | kg |
| | 25 | 37,5 | | 1,25 | 25 | | | | 37,5 | | | 0,05 |
| | 38 | 57 | | 1,25 | 38 | | | | 57 | | | 0,12 |
| | 51 | 76,5 | | 1,25 | 51 | | | | 76,5 | | | 0,18 |
| | 63,5 | 95,25 | | 1,5 | 63,5 | | | | 95,25 | | | 0,33 |
| | 76 | 114,15 | | 1,6 | 76,1 | | | | 114,15 | | | 0,50 |
| | 101,6 | 150 | | 2,0 | 101,6 | | | | 150 | | | 0,87 |
| | | | | | | | | | | | | |
| | | | | | | | | | | | | |
| | | | | | | | | | | | | |
| | | | | | | | | | | | | |
| | | | | | | | | | | | | |

| Угольник 90° W - W, СМС | 31020 | Размеры | | | | | | | | | | |
|-------------------------|-------|---------|---|------|-------|---|---|---|-----|---|--------|------|
| | SMS | DN | A | B | C | D | E | F | r | L | Rd x s | kg |
| | 25 | 75 | | 1,25 | 25 | | | | 38 | | | 0,15 |
| | 38 | 90 | | 1,25 | 38 | | | | 56 | | | 0,21 |
| | 51 | 100 | | 1,25 | 51 | | | | 72 | | | 0,31 |
| | 63,5 | 115 | | 1,5 | 63,5 | | | | 84 | | | 0,45 |
| | 76 | 130 | | 1,6 | 76,1 | | | | 85 | | | 0,67 |
| | 101,6 | 150 | | 2,0 | 101,6 | | | | 110 | | | 1,27 |
| | | | | | | | | | | | | |
| | | | | | | | | | | | | |
| | | | | | | | | | | | | |
| | | | | | | | | | | | | |
| | | | | | | | | | | | | |

| Угольник 180° С-С | 31340 | Размеры | | | | | | | | | | |
|-------------------|-------|---------|--------|------|-------|---|---|---|---|---|--------|------|
| | SMS | DN | A | A1 | C | D | E | F | R | L | Rd x s | kg |
| | 25 | 75 | 37,5 | 1,25 | 25 | | | | | | | 0,05 |
| | 38 | 114 | 57 | 1,25 | 38 | | | | | | | 0,12 |
| | 51 | 153 | 76,5 | 1,25 | 51 | | | | | | | 0,18 |
| | 63,5 | 190,5 | 95,25 | 1,5 | 63,5 | | | | | | | 0,33 |
| | 76 | 228,3 | 114,15 | 1,6 | 76,1 | | | | | | | 0,50 |
| | 101,6 | 304,2 | 152,1 | 2,0 | 101,6 | | | | | | | 0,87 |
| | | | | | | | | | | | | |
| | | | | | | | | | | | | |
| | | | | | | | | | | | | |
| | | | | | | | | | | | | |
| | | | | | | | | | | | | |

| Т - деталь С - С - С, СМС (короткий) | 31400 | Размеры | | | | | | | | | | |
|--------------------------------------|-------|---------|------|------|-------|---|---|---|---|---|--------|------|
| | SMS | DN | A | A1 | C | D | E | F | R | L | Rd x s | kg |
| | 25 | 55 | 14 | 1,25 | 25 | | | | | | | 0,11 |
| | 38 | 70 | 21 | 1,25 | 38 | | | | | | | 0,25 |
| | 51 | 82 | 28,5 | 1,25 | 51 | | | | | | | 0,47 |
| | 63,5 | 105 | 36 | 1,5 | 63,5 | | | | | | | 0,75 |
| | 76 | 110 | 43 | 1,6 | 76,1 | | | | | | | 1,07 |
| | 101,6 | 150 | 58 | 2,0 | 101,6 | | | | | | | 2,30 |

| Т - деталь С - С - С, СМС (длинный) | 31410 | Размеры | | | | | | | | | | |
|-------------------------------------|-------|---------|---|------|-------|---|---|---|---|---|--------|------|
| | SMS | DN | A | B | C | D | E | F | R | L | Rd x s | kg |
| | 25 | 55 | | 1,25 | 25 | | | | | | | 0,11 |
| | 38 | 70 | | 1,25 | 38 | | | | | | | 0,25 |
| | 51 | 82 | | 1,25 | 51 | | | | | | | 0,47 |
| | 63,5 | 105 | | 1,5 | 63,5 | | | | | | | 0,75 |
| | 76 | 110 | | 1,6 | 76,1 | | | | | | | 1,07 |
| | 101,6 | 150 | | 2,0 | 101,6 | | | | | | | 2,30 |

| Т - деталь С - С - С, СМС (короткий) | 31440 | Размеры | | | | | | | | | | |
|--------------------------------------|--------|---------|------|------|-------|------|---|---|---|---|--------|------|
| | SMS | DN | A | A1 | C | D | E | F | r | L | Rd x s | kg |
| | 38/25 | 70 | 21 | 1,25 | 38 | 25 | | | | | | 0,17 |
| | 51/25 | 82 | 29 | 1,25 | 51 | 25 | | | | | | 0,26 |
| | 51/38 | 82 | 29 | 1,25 | 51 | 38 | | | | | | 0,27 |
| | 63/25 | 105 | 34,5 | 1,5 | 63,5 | 25 | | | | | | 0,49 |
| | 63/38 | 105 | 35 | 1,5 | 63,5 | 38 | | | | | | 0,51 |
| | 63/51 | 105 | 36 | 1,5 | 63,5 | 51 | | | | | | 0,51 |
| | 76/25 | 110 | 41 | 1,6 | 76,1 | 25 | | | | | | 0,60 |
| | 76/38 | 110 | 42 | 1,6 | 76,1 | 38 | | | | | | 0,68 |
| | 76/51 | 110 | 43 | 1,6 | 76,1 | 51 | | | | | | 0,68 |
| | 76/63 | 110 | 43 | 1,6 | 76,1 | 63,5 | | | | | | 0,81 |
| | 101/25 | 150 | 56 | 2,0 | 101,6 | 25 | | | | | | 0,82 |
| | 101/38 | 150 | 56 | 2,0 | 101,6 | 38 | | | | | | 0,90 |
| | 101/51 | 150 | 57 | 2,0 | 101,6 | 51 | | | | | | 0,95 |
| | 101/63 | 150 | 58 | 2,0 | 101,6 | 63,5 | | | | | | 0,96 |
| | 101/76 | 150 | 58 | 2,0 | 101,6 | 76,1 | | | | | | 0,92 |

| Крест С - С - С - С, СМС | 31540 | Размеры | | | | | | | | | | |
|--------------------------|-------|---------|-----|------|-------|---|---|---|---|---|--------|------|
| | SMS | DN | A | A1 | C | D | E | F | R | L | Rd x s | kg |
| | 25 | 55 | 28 | 1,25 | 25 | | | | | | | 0,09 |
| | 38 | 70 | 42 | 1,25 | 38 | | | | | | | 0,19 |
| | 51 | 82 | 57 | 1,25 | 51 | | | | | | | 0,25 |
| | 63,5 | 105 | 72 | 1,5 | 63,5 | | | | | | | 0,51 |
| | 76 | 110 | 86 | 1,6 | 76,1 | | | | | | | 0,69 |
| | 101,6 | 150 | 116 | 2,0 | 101,6 | | | | | | | 0,93 |

